

構成内容 / Components				
No.	名称 / Part name	数量 / Pcs	材質 / Material	色・表面処理 / Color・Finish
1	上下カバー Top and Bottom cover	各1 1 each	アルミ板 A1100P t2.0 Aluminium A1100P t2.0	シルバーアルマイト Silver・Anodized
2	Wパネル W Panel	2	アルミ板 A1100P t2.0 Aluminium A1100P t2.0	シルバーアルマイト Silver・Anodized
3	Dパネル D Panel	2	アルミ板 A1100P t2.0 Aluminium A1100P t2.0	シルバーアルマイト Silver・Anodized
4	支柱 Extruded Pillar	4	アルミ押出材 A6063S-T5 Extruded aluminium A6063S-T5	シルバーアルマイト Silver・Anodized
5	取付用ローレットビス(M4 x 8) Knurled Thumb Screw(M4 - 8)	8	真ちゆう Brass	ニッケルメッキ Nickel plated
6	ゴム足 / Rubber feet	4	ポリウレタン / Polyurethane	透明 / Transparent

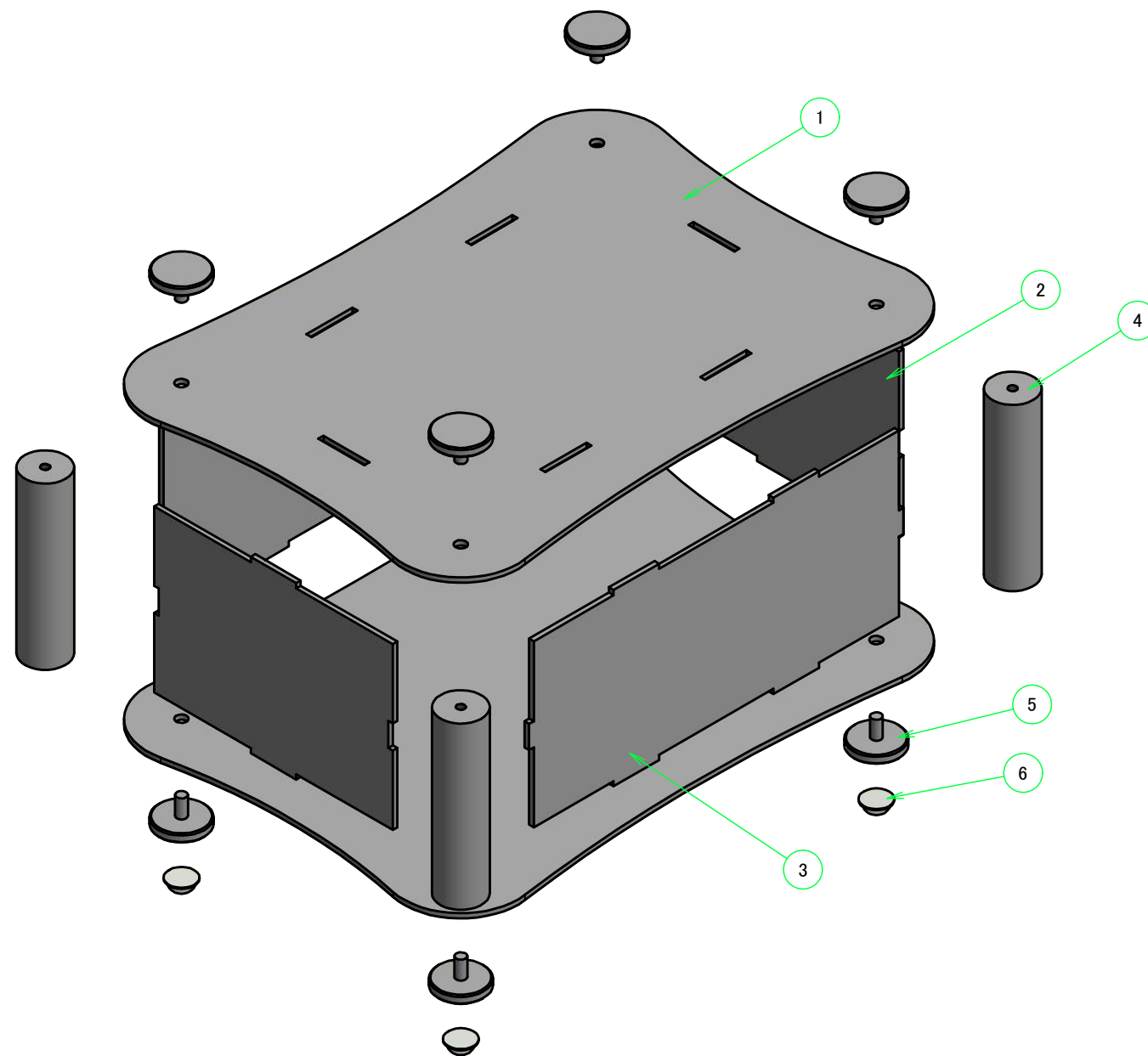

取付用ローレットビス / Knurled Thumb Screw

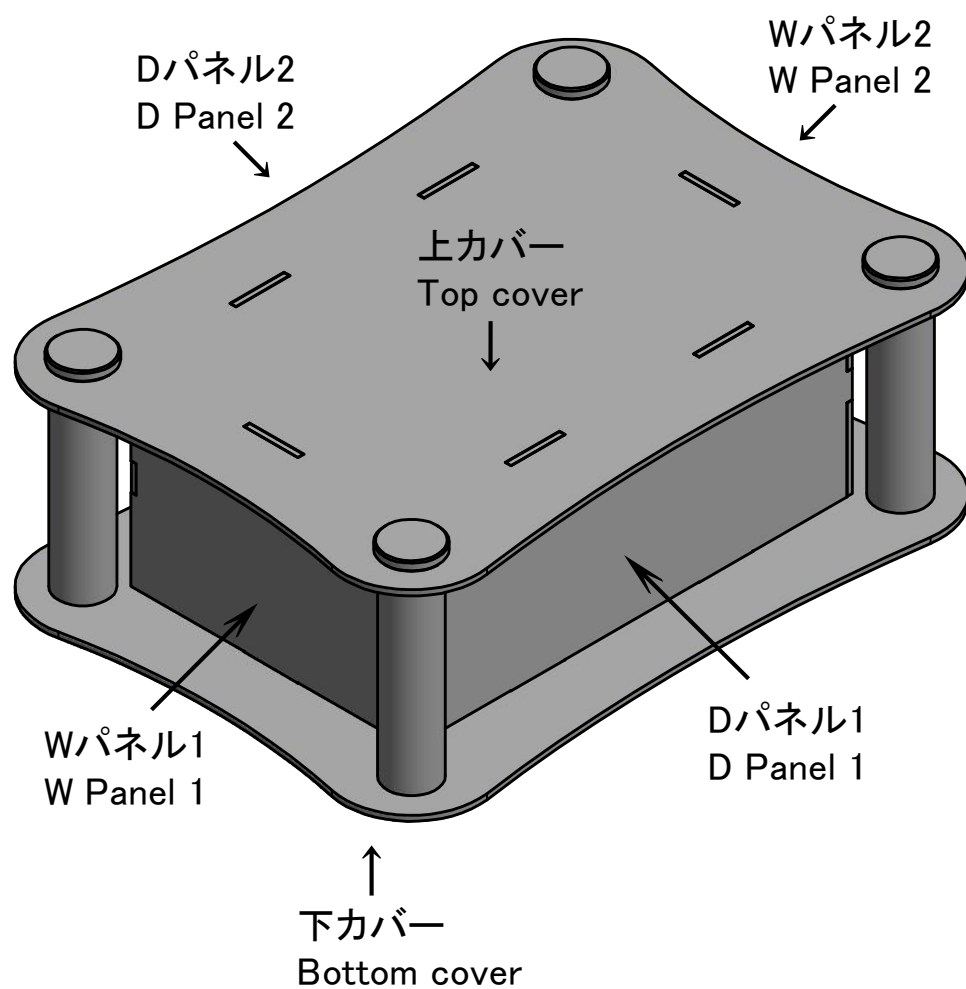
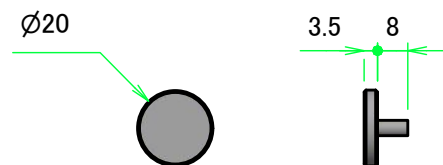

ゴム足 / Rubber feet

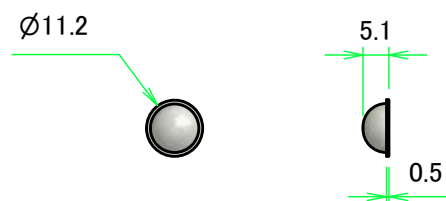

*ゴム足は任意の位置に貼り付けできます。
*Adhesive rubber feet in cluded

株式会社タカチ電機工業 TAKACHI ELECTRONICS ENCLOSURE CO., LTD.			品名/Title 曲線型アルミケース ARC DESIGN ALUMINIUM CASE	尺度/Scale 1:2
承認/Approved	検図/Checked	製図/Created	型番/Product number ALR11-8-17	
中根	横田	常山	作成日/Date 2020/10/14	1 / 5

外視 / External View

Wパネル2 / W Panel 2

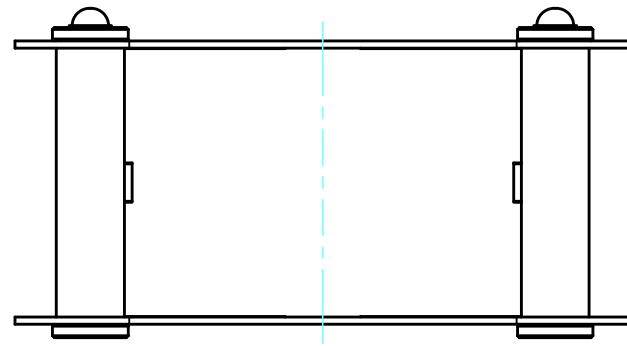

Dパネル2 / D Panel 2

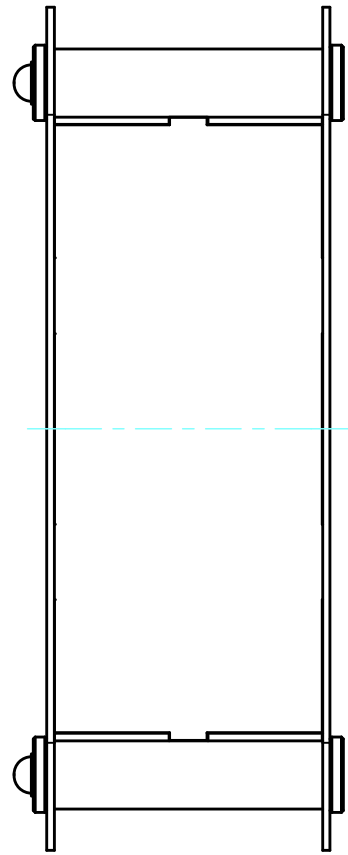

上カバー / Top cover

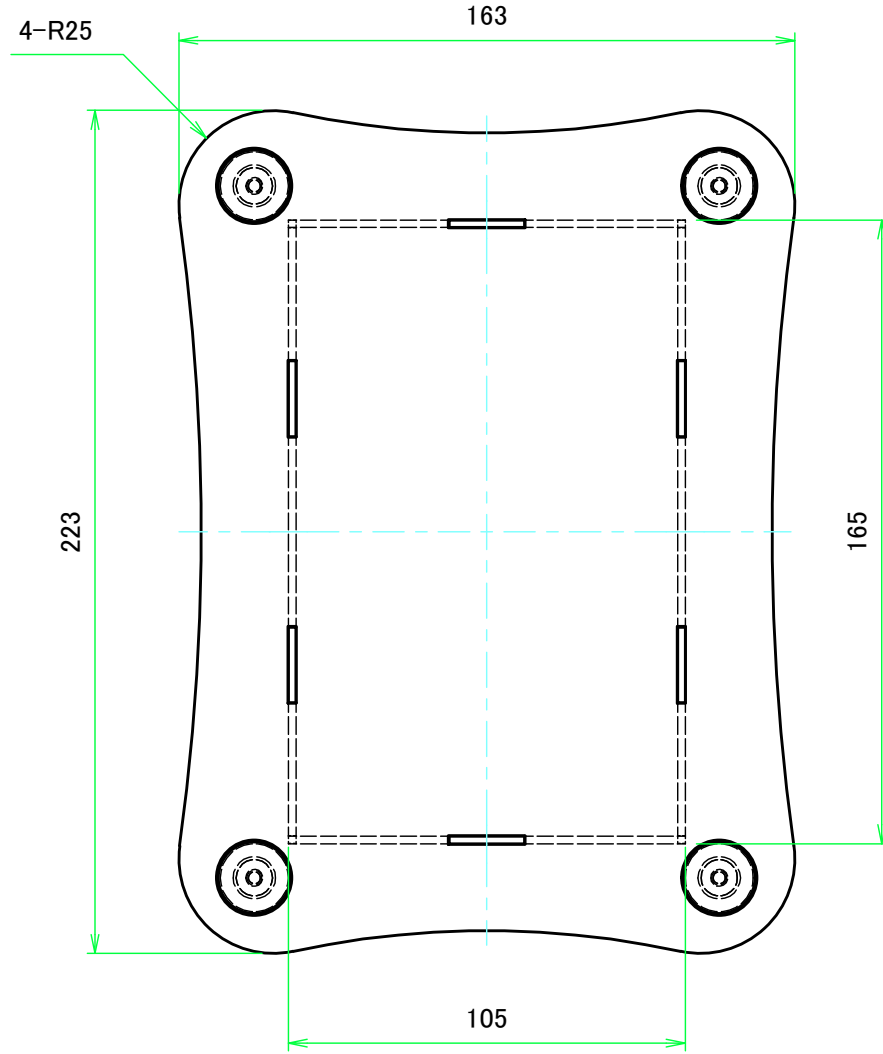

Dパネル1 / D Panel 1

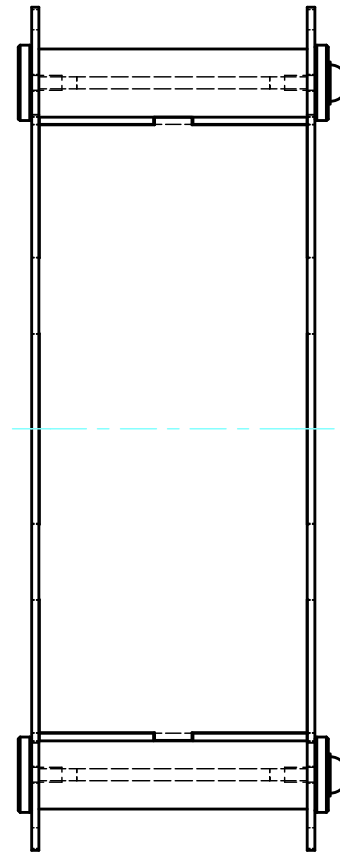

下カバー / Bottom cover

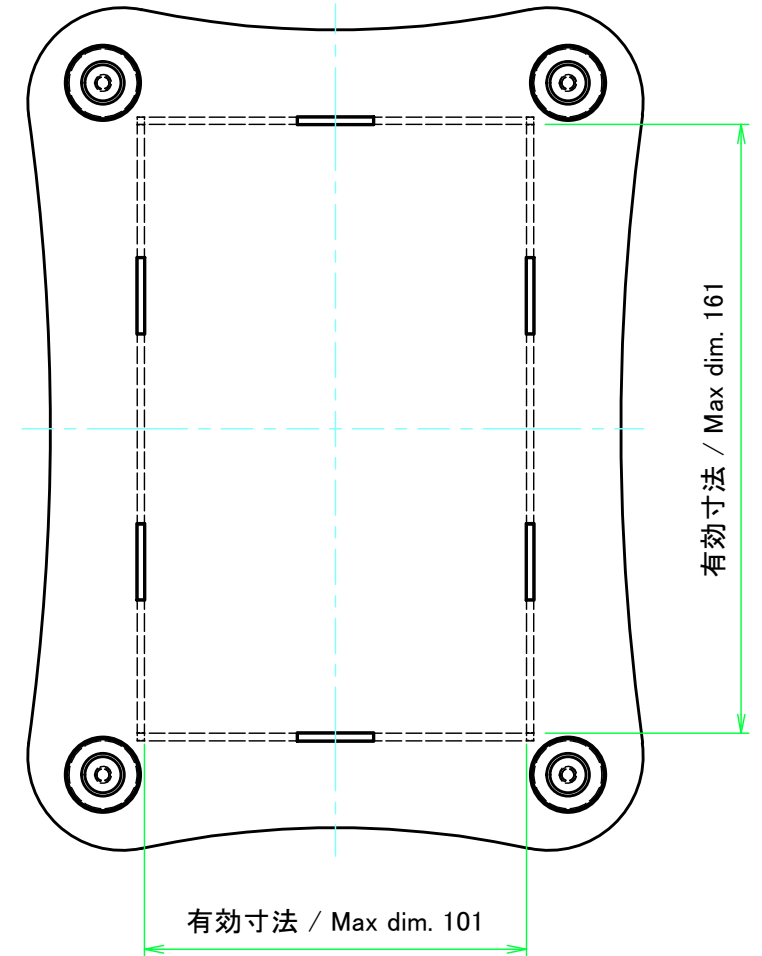

Wパネル1 / W Panel 1

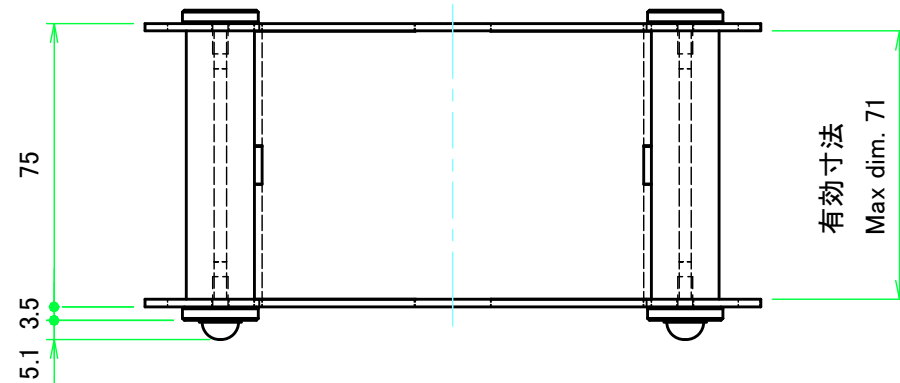

株式会社タカチ電機工業 TAKACHI ELECTRONICS ENCLOSURE CO., LTD.			品名/Title 曲線型アルミケース ARC DESIGN ALUMINIUM CASE	尺度/Scale 1:2
承認/Approved	検図/Checked	製図/Created	型番/Product number ALR11-8-17	
中根	横田	常山	作成日/Date 2020/10/14	2 / 5

上下カバー / Top and Bottom cover

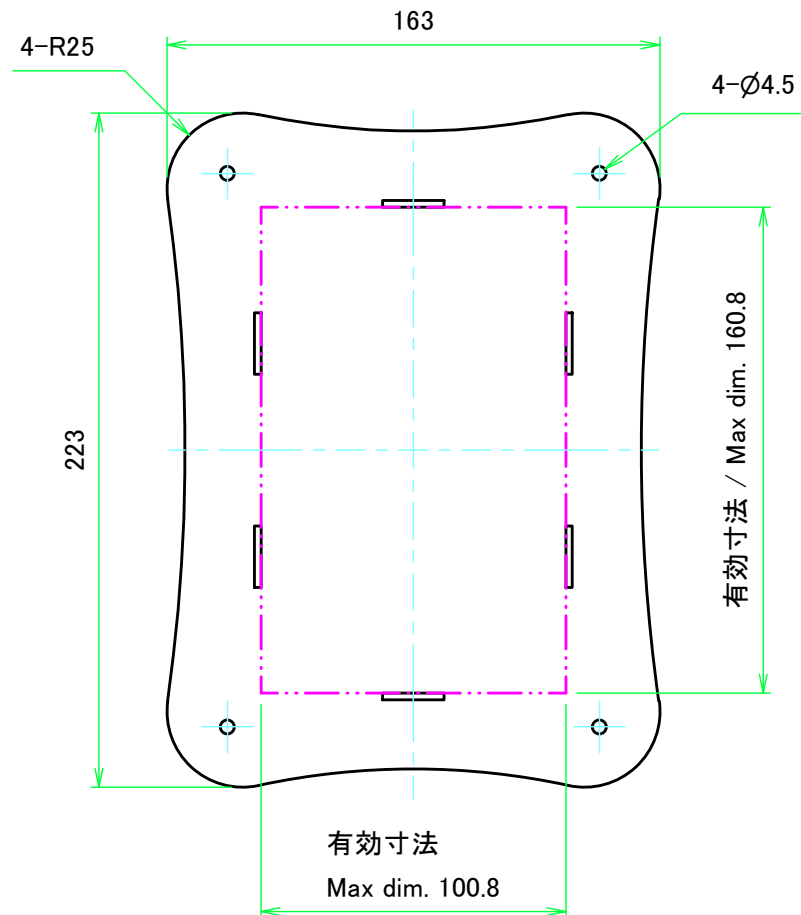

上カバー表面 / Top cover Frontside

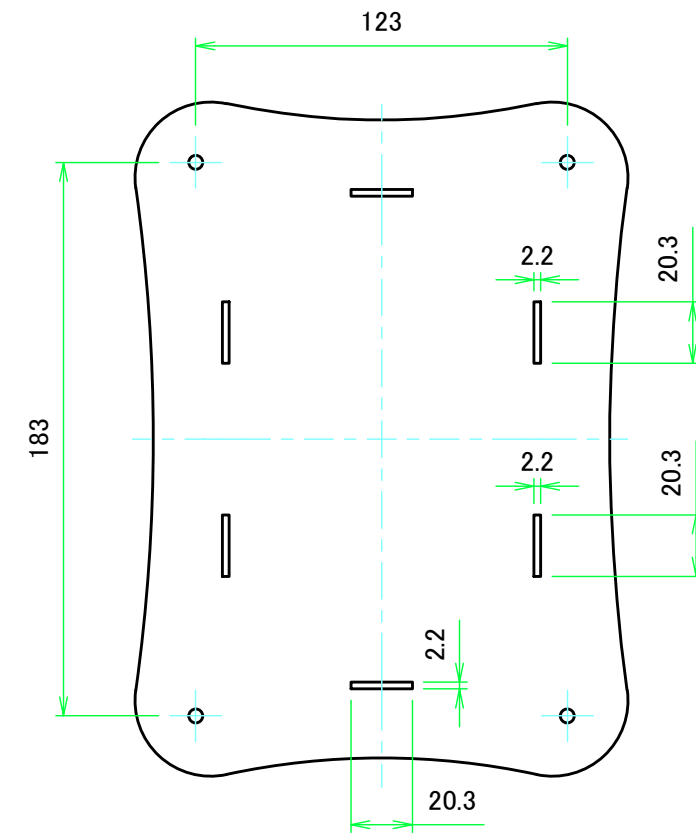

上カバー裏面 / Top cover Backside

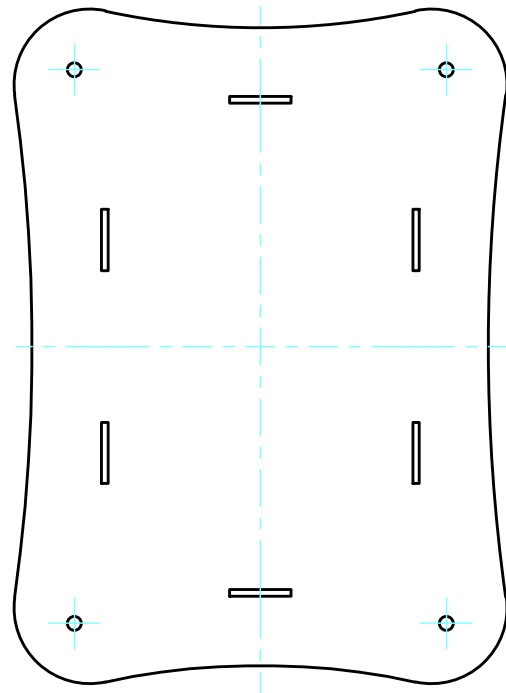

下カバー表面 / Bottom cover Frontside

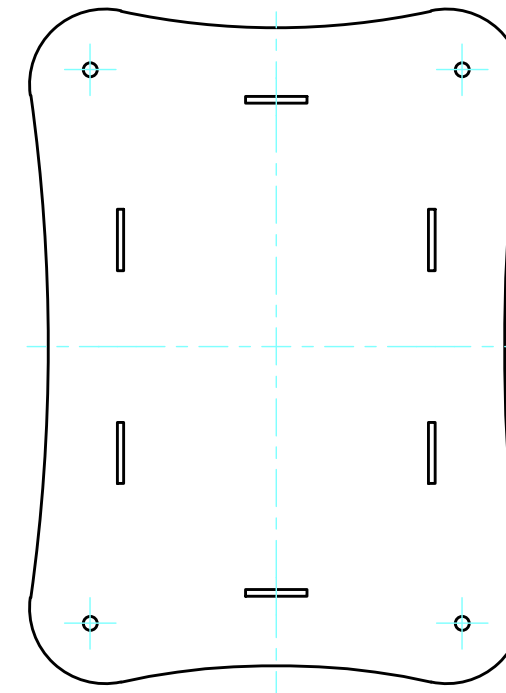

下カバー裏面 / Bottom cover Backside

株式会社タカチ電機工業 TAKACHI ELECTRONICS ENCLOSURE CO., LTD.			品名/Title 曲線型アルミケース ARC DESIGN ALUMINIUM CASE	尺度/Scale 1:2.5
承認/Approved	検図/Checked	製図/Created	型番/Product number ALR11-8-17	
中根	横田	常山	作成日/Date 2020/10/14	3 / 5

Wパネル / W Panel

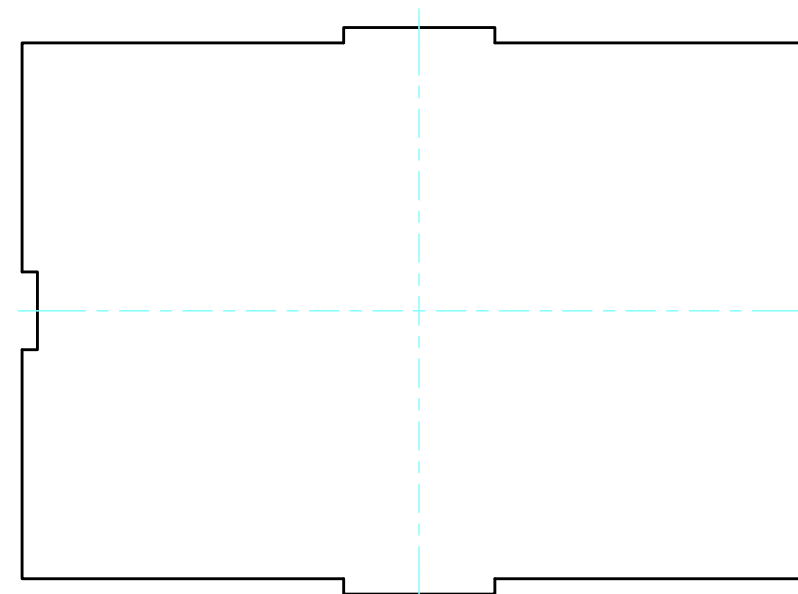
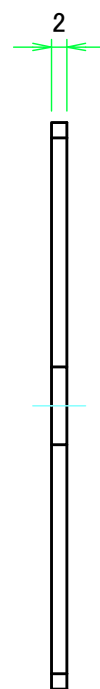
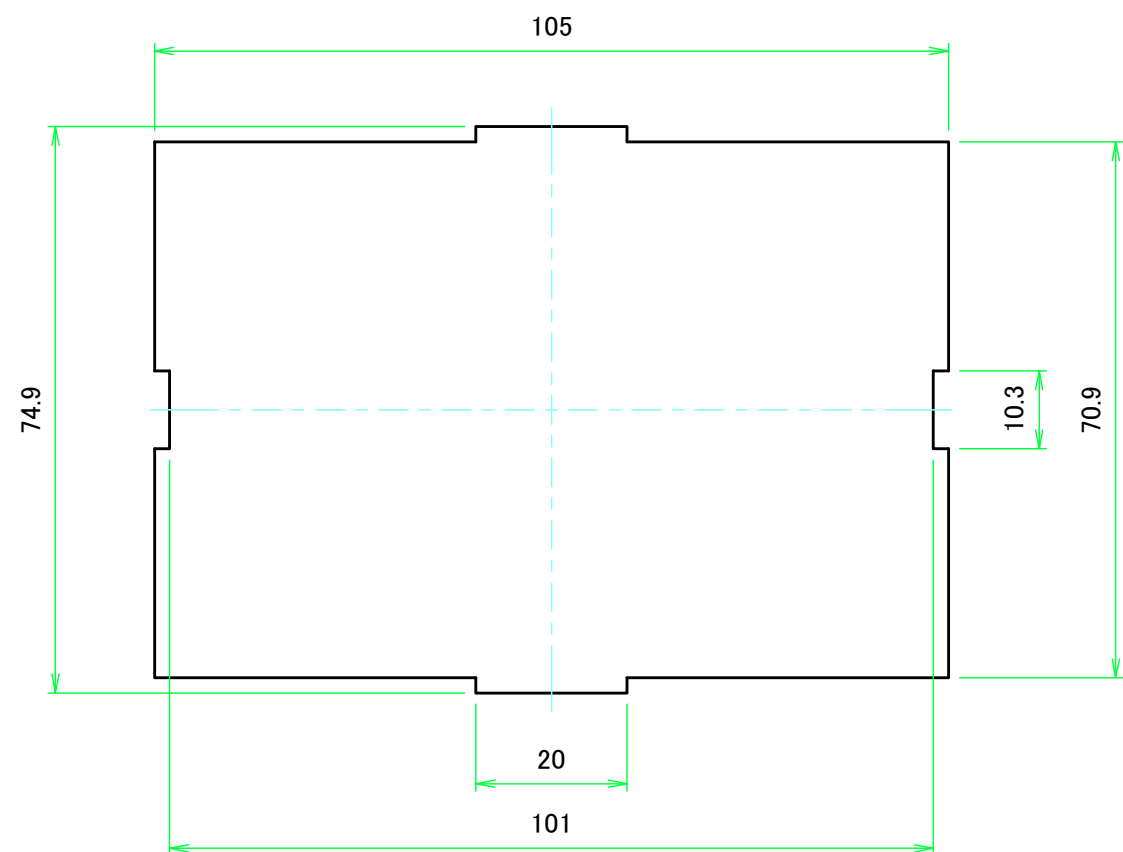

Wパネル1表面 / W Panel 1 Frontside

Wパネル1裏面 / W Panel 1 Backside

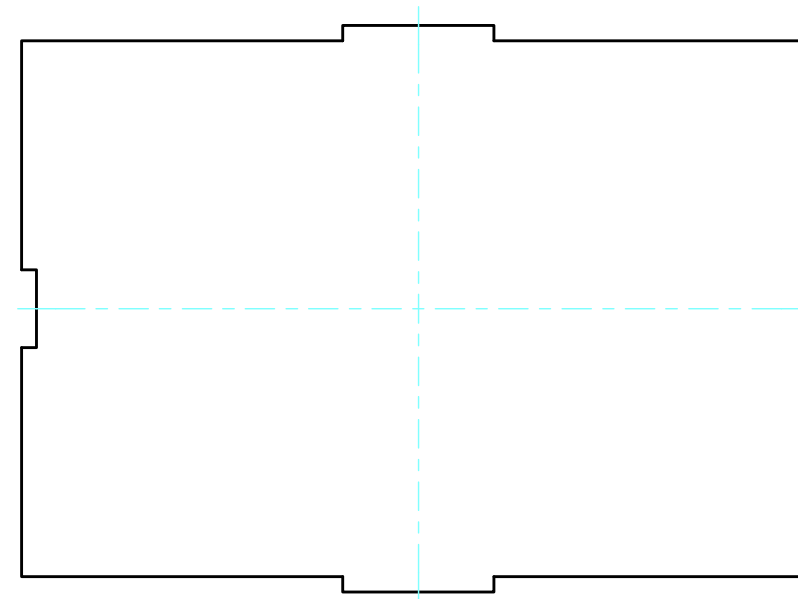
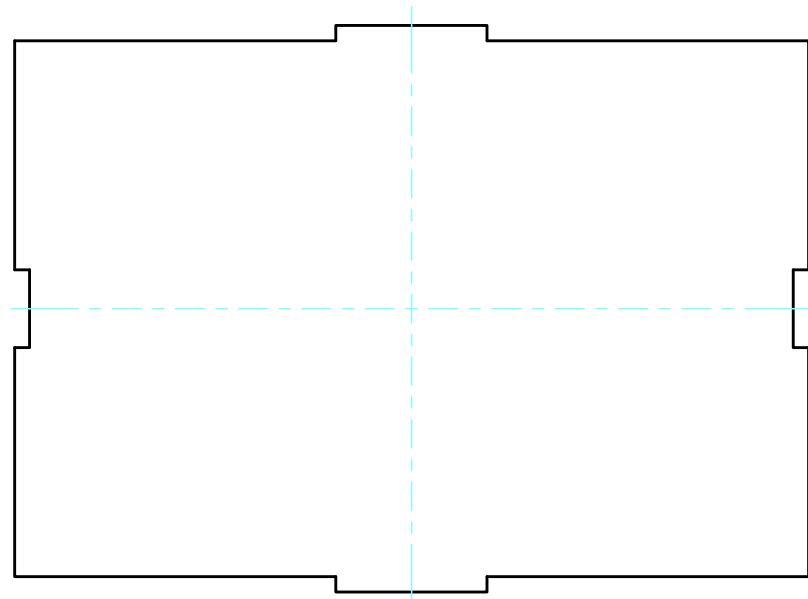

Wパネル2表面 / W Panel 2 Frontside

Wパネル2裏面 / W Panel 2 Backside

株式会社タカチ電機工業 TAKACHI ELECTRONICS ENCLOSURE CO., LTD.			品名/Title 曲線型アルミケース ARC DESIGN ALUMINIUM CASE	尺度/Scale 1:1
承認/Approved	検図/Checked	製図/Created	型番/Product number ALR11-8-17	
中根	横田	常山	作成日/Date 2020/10/14	4 / 5

Dパネル / D Panel

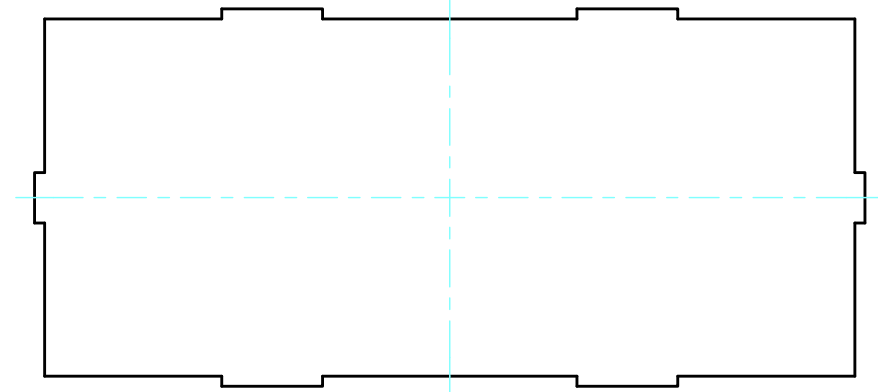
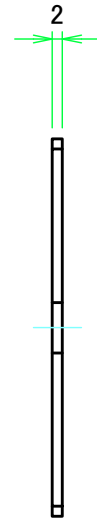
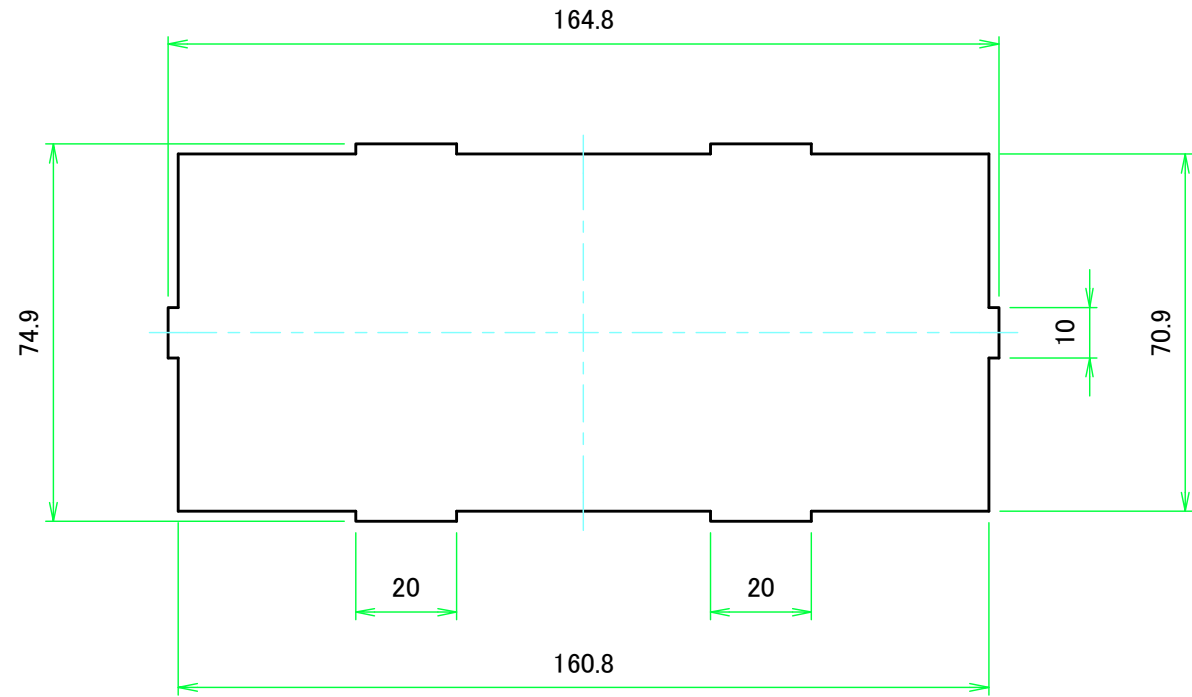

Dパネル1表面 / D Panel 1 Frontside

Dパネル1裏面 / D Panel 1 Backside

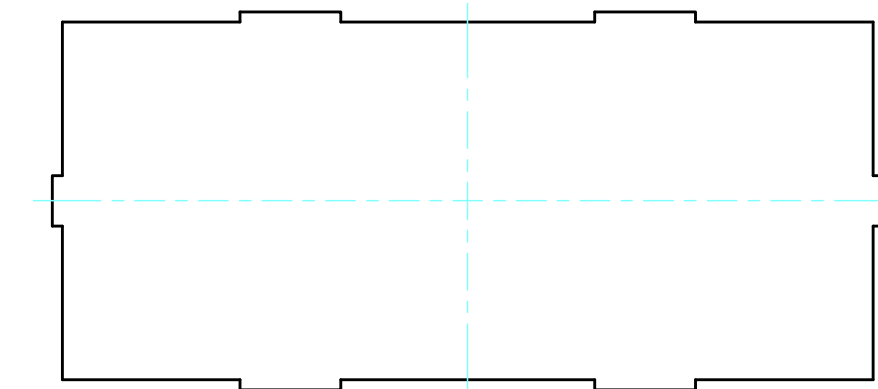
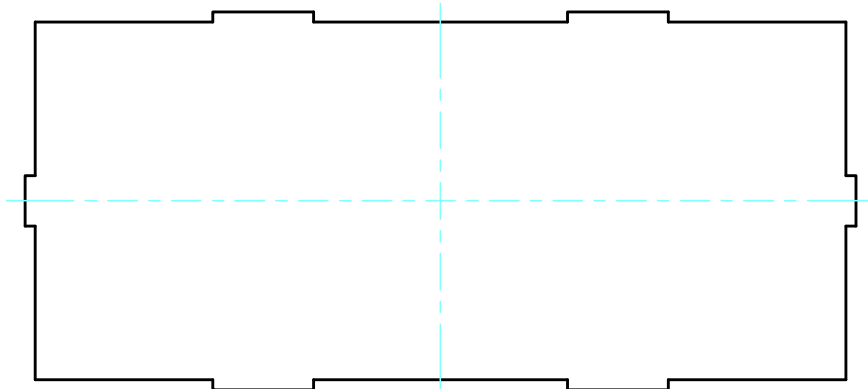

Dパネル2表面 / D Panel 2 Frontside

Dパネル2裏面 / D Panel 2 Backside

株式会社タカチ電機工業 TAKACHI ELECTRONICS ENCLOSURE CO., LTD.			品名/Title 曲線型アルミケース ARC DESIGN ALUMINIUM CASE	尺度/Scale 1:1.5
承認/Approved	検図/Checked	製図/Created	型番/Product number ALR11-8-17	
中根	横田	常山	作成日/Date 2020/10/14	5 / 5